

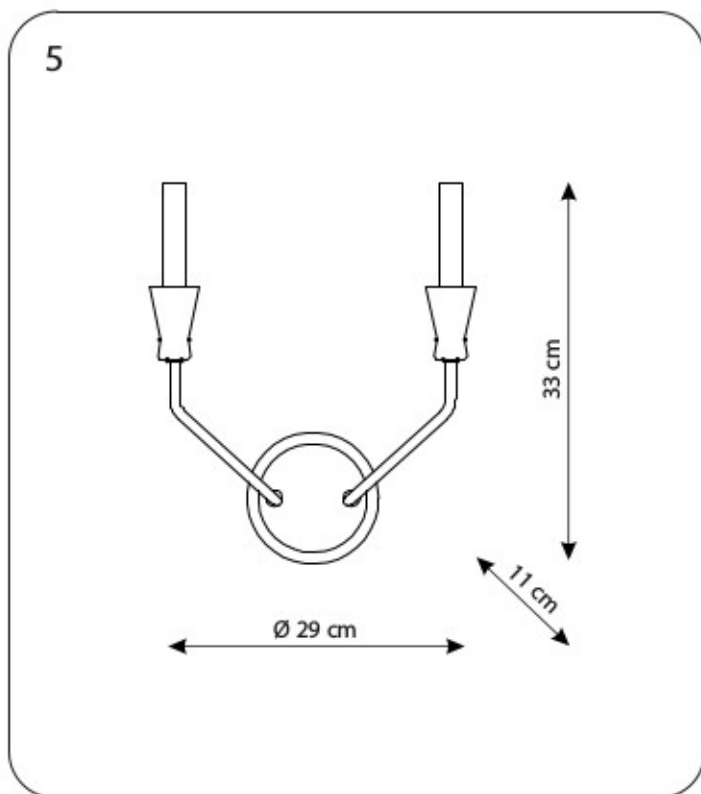

**ИНСТРУКЦИЯ ПО УСТАНОВКЕ И
ПОДКЛЮЧЕНИЮ СВЕТИЛЬНИКА**

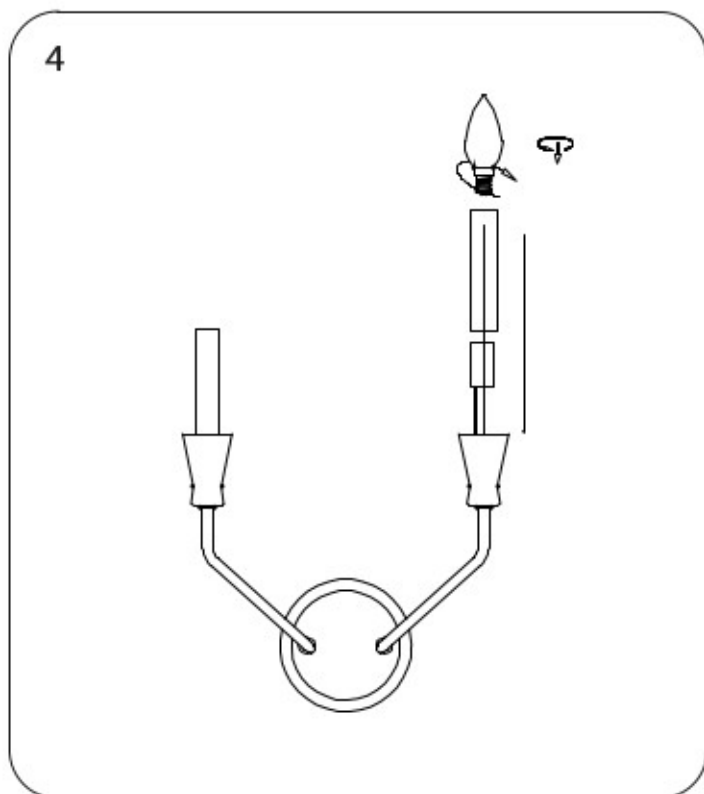

732527

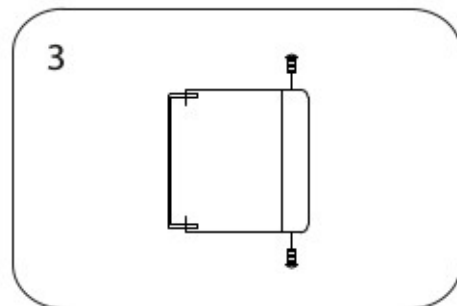
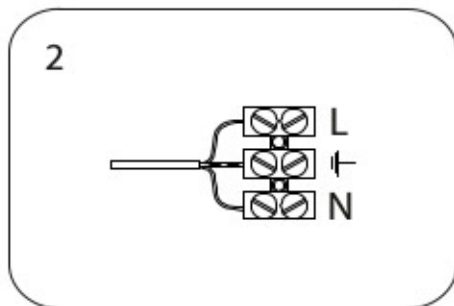
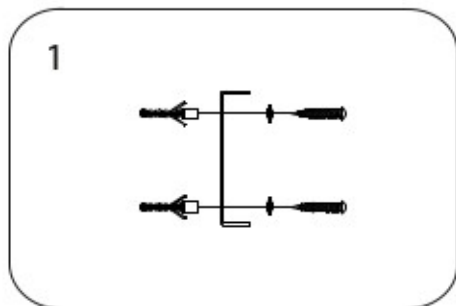